

---

# USE & CARE GUIDE

## Solar Umbrella

KSN: 08769105-1

UPC Code: 749241315183

Date of purchase: \_\_\_\_/ \_\_\_\_/ \_\_\_\_

## Thank you for your purchase

---

### Thank you for your purchase!

We are pleased that you have chosen Kmart for your outdoor furniture purchase. We hope that you enjoy the unmatched quality, comfort, and style of your new patio set. Every piece is meticulously considered all the way down to the smallest details, exclusively for you, by our world class design team. We know you have a choice when it comes to your patio furniture needs, so from our team to yours, thank you for letting us be a part of your outdoors.

## Table of contents

---

<b>Table of Contents</b> .....	2
<b>Safety Information</b> .....	3
Set Up your Umbrella Properly .....	3
Examine your Umbrella .....	3
<b>Warranty</b> .....	3
Excluded .....	3
Service Center .....	3
<b>Care and Maintenance</b> .....	4
<b>Pre-Assembly</b> .....	5
Package Contents .....	5
<b>Assembly Instructions</b> .....	6
<b>Customer Service</b> .....	8

## Safety Information

---

### SET UP YOUR SHELTER PROPERLY

- Please read and understand this entire manual before attempt to assemble, operate, or install the product.
- If any part is missing or damaged. Do not attempt to assemble the product.
- Do not use the structure as support.
- Keep instructions for future use.

### EXAMINE YOUR UMBRELLA

- Examine occasionally to ensure there are no loose parts. If loose parts are found, they should be retightened immediately.

## Warranty

---

### 1 YEAR WARRANTY FOR FRAME AND FABRIC

Limited warranty is applicable on parts only. Warranty extends solely to the original purchaser who must offer original sales receipt for record.

### WHAT IS COVERED

Limited parts warranty covers original purchaser from date of purchase for one year. Warranty ensures umbrella fabric cover, umbrella frame, solar panel, light bulb will be free from manufacturing defects.

### WHAT IS NOT COVERED

Product used for commercial, contract, or other non-residential purposes, or damage due to acts of nature, vandalism, misuse, or improper assembly is not covered. Corrosion or rusting of hardware is not covered. Warranty is to the original purchaser and is non-transferable. Any replacement of warranted items will be in the original style and color, or a similar style and color if the original is unavailable or has been discontinued.

### SERVICE CENTER

The purchaser must contact our customer service center directly if this product is found to be defect in material or workmanship. The manufacturer, as its option, will repair or replace the defectives parts. Please contact us via 1-800-961-9838, 9AM-5PM, Pacific Time Zone, Monday-Friday, or [customerservice@bondvast.com](mailto:customerservice@bondvast.com)

## Care and Maintenance

---

- For cleaning, use a mild detergent solution and rinse with water. Do not use acetone abrasive or others special detergents to clean and air dry only.
- Due to the nature of aluminum, surface oxidation (rusting) will occur if this protective coating is scratched. This is a natural process. To minimize this condition, it is recommended that care be taken when assembling and handling the product in order to prevent the paint from being scratched.

## Pre-Assembly

---

### PLANNING ASSEMBLY



To prevent damage, place all parts on a soft surface during assembly.

Do not leave it unattended if not fully assembled even if bolted to the ground.

## Pre-Assembly

---

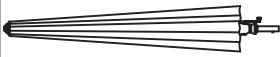
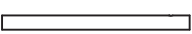
Part content

PART	DESCRIPTION	PICTURE	QTY.
A	Umbrella		1
B	Bottom Tube		1
C	Solar Panel		1

# Assembly Instructions

## SOLAR POWER UMBRELLA

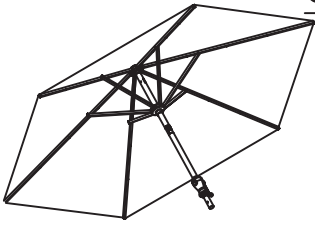

Please read the instructions thoroughly before you start to assemble this umbrella. This solar power umbrella has the electronic solar power panel on top the umbrella and wires on the umbrella ribs. Please handle this umbrella with extra care and avoid any dropping.

**Do not use this umbrella during windy conditions.**

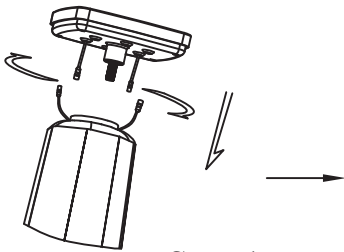

Step 1:

1. Screw-in the solar panel to the top of the umbrella, and then connect wires together.

Please make sure wires connect in same color.

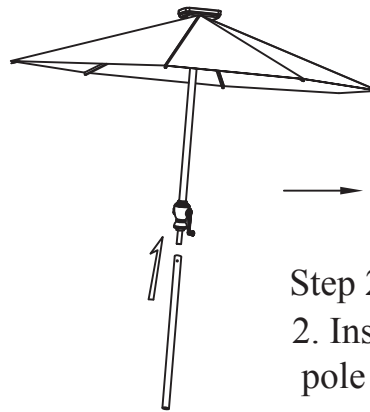

Step 2:

2. Insert the Bottom pole with Umbrella.

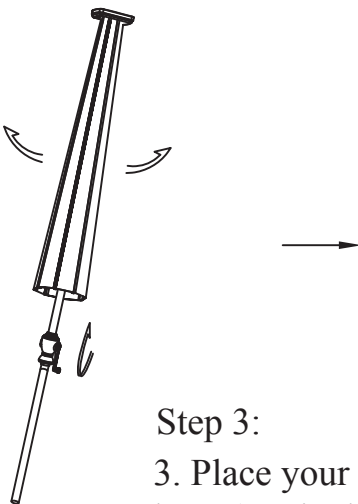

Step 3:

3. Place your umbrella on the umbrella base (not included). Please make sure umbrella is firmly secured with umbrella base.



Step 4:

4. Turn the crank in clockwise to unfold the umbrella.

## Assembly Instructions

---

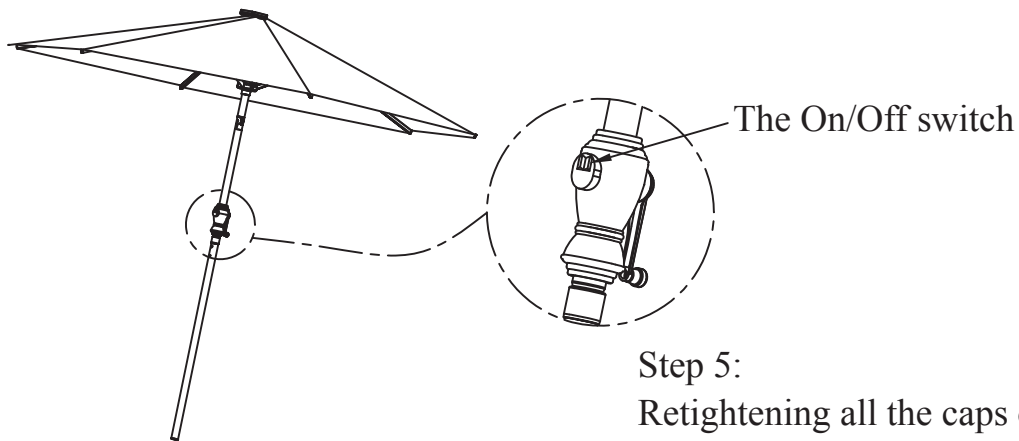

Step 5:  
Retightening all the caps of lights before  
turn the lights.  
Push the on/off switch to turn the lights.

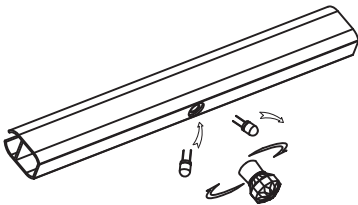

Remark: To replace the LED bulbs

1. Screw down the plastic bulb cover and unfasten the LED bulb.
2. Replace the new LED bulb and screw the plastic bulb cover.

Warning: Check that the “+” and “-“ is correctly placed on the LED bulb if the lights are not working.

Warning: This LED bulb is special design for this product only.  
Do not replace any other product or modified.

It takes up to 6 hours to fully charge the battery in the sunny day condition.  
Once the battery is fully charge it will last for 5 to 6 hours.



## BOND VAST INDUSTRIAL LIMITED

---



No. 174 Ding Tan Pi Tan Vill Lutsao Hsiang, Chla Yi Hsien, Tai Wan, ROC

FAX: 886-5-3651 522

CUSTOMER SERVICE HOT LINE: 1-800-961-9838

SERVICE HOURS: MONDAY - FRIDAY 9:00AM - 5:00PM (PACIFIC TIME)

E-MAIL: [CUSTOMERSERVICE@BONDVAST.COM](mailto:CUSTOMERSERVICE@BONDVAST.COM)





Please refer to part numbers when reordering

For questions or comments about product:

Email: [customerservice@bondvast.com](mailto:customerservice@bondvast.com) or Call toll-free: 1-800-961-9838

Made in / Hecho en CHINA for Kmart Corporation, Hoffman Estates, IL 60179

See our extensive assortment of outdoor living products  
on-line at [ww.sears.com](http://ww.sears.com) and [www.kmart.com](http://www.kmart.com)